

RoHS Compliant

P1

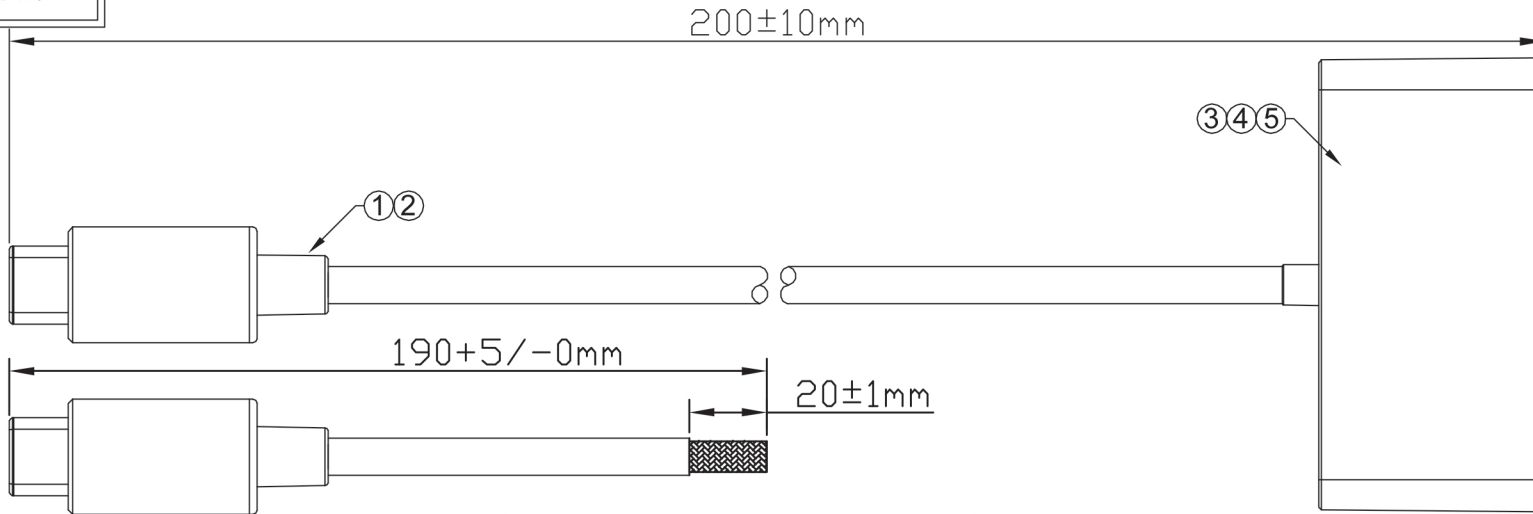

P2

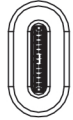
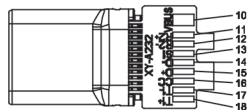
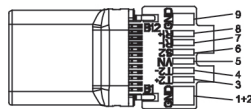
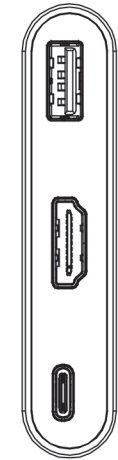

TYPE-C

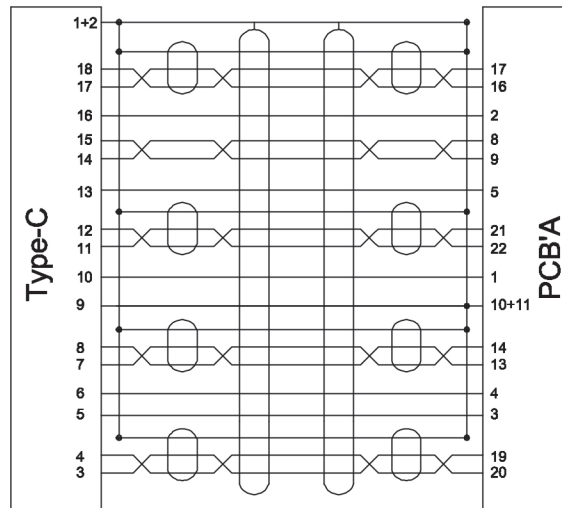

TEST PARAMETER:

1. Solution:3840\*2160P/30Hz
2. USB DATA TEST
3. PD POWER TEST

PCB'A  
CHIP MODEL:VL100+PS176+VL210

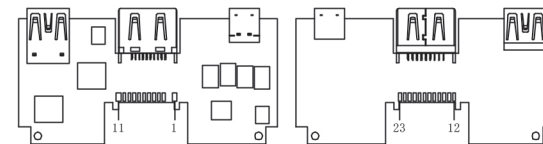

5	Heat Shrink	WHITE HEAT SHRINK , Φ1.0*L=8mm	1 Pcs
4	MOULDING	60P PVC Black	1.00g
3	INNER	Type-C to HDMI/VGA INNER MOULD	1 Pcs
	FRONT COVER	Type-C to HDMI+USB+Type-C ABS FORNT SHELL	1 Pcs
	ABS SHELL	Type-C to HDMI/VGA+USB+Type-C BLACK ABS SHELL	1 Pcs
	CLAMP	TYPE-C CLAMP	1 Pcs
	CONN	TYPE C TO HDMI A/F + USB 3.0 A/F + PD NICKEL CONNECTOR	1 Pcs
2	ABS SHELL	Type-C/M ABS SHELL Φ5.2	1 Pcs
1	CABLE	Type-C OPEN CABLE UL2725 (7/0.06T*1P+D+AL+HM)*4C+7/0.08T*1P+7/0.06T*4C+7/0.20T*2C+F+D+AB16/9/0.08T, JACKET PVC BLACK, OD:4.2±0.20mm (, USB 3.1)	0.5Pcs
NO	PART NO	SPEC	QTY

(DWG NO)	806-0427	(UNIT)
(REV)	A0	(SCALE)
(PAGE)	1/1	
(DESIGN)	YOU	TOLERANCE UNSPECIFIED
(CHECKED)		XX ±0.25
(APPROVED)		XXX ±0.15
		XXX ±0.05
		X° ±5°
		XX° ±2°

**Weltron**®

Description: Type-C to HDMI A/F +  
USB 3.0 A/F + Type-C/F Cable

Part No: 91-735