

Weltron®

WS-7060BK

User Manual

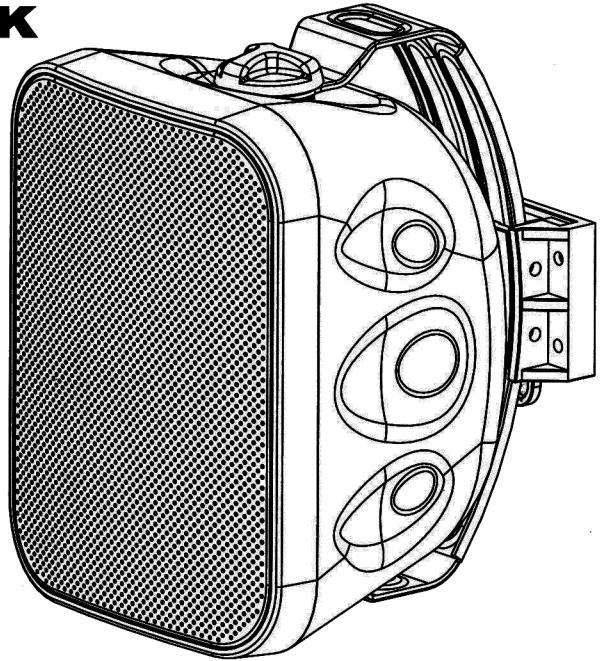

Outdoor and Indoor
SPEAKER

Introduction

Thank you for buying outdoor and indoor speaker. Please read and have a thorough understanding of the entire manual before installation and use. Keep the manual for maintenance.

IMPORTANT: LumiAudio has made every effort to provide accurate and detailed instruction for this product's assembly and installation. Should you have any doubts consult a qualified professional fitter. LumiAudio recognizes no liability for any difficulty or problem derived from the interpretation of these instructions. These brackets and all their parts and accessories must only be used for the purpose they have been constructed. LumiAudio, its commercial distributors and retailers are not , directly or indirectly, responsible for any damage to persons and or properties derived from the use of this product in an unsafe or different way for which it has been designed and constructed.

Several parts of this product are small pieces of hardware therefore extreme care should be taken to keep them from children.

Read these instructions carefully before using the product

1. When the speakers are installed in walls, check that the wall structure is reliable and that the speaker is firmly attached. The user should be responsible for this very thing.
2. Do not install the speakers in fine wood or soft wall material because the screws can get loose, causing the crash or breakdown of the speakers and personal injury.
3. Don not use nails, adhesives or other unauthorized devices. Long-term use and vibrations may cause it to fall easily.
4. Do not place the speakers on a turntable or movable support.
5. Do not touch or bump the woofer and tweeter. If these are damaged, the sound will be distorted.
6. Do not listen to sound at a very high level when you are changing the input source (for example, to tune FM / CD) Installation or removal of cables should make sure that the power amp / amplifier device radio is turned off.
7. Do not attempt to clean the speakers with chemical solvents as this may damage the paint surface. Clean with a dry cloth.

Users have a responsibility to place or install safety.

The speakers that are placed in the holder can be either wall or ceiling type, using screws to be placed inside of the speakers in the back is optional.

1. Mark the mounting bracket as a template with the regional location of the hole slots.
2. Then use the appropriate hardware and tools (not supplied) are properly fixed to the bracket wall/ceiling
3. Place the speakers to the bracket using the screws and washers according to the speaker.

Connection

Use wire on the back of the speaker in the output tab of the amplifier (or amplifiers of radio). The speaker wire is on one side red and on the other one black. Connect to he red side of the amplifier and speakers (+) tab. Connect one end of the black side (-) in the other tab. Connect each speaker to make sure that is not (+,-) inverted polarity. If the polarity of the speakers is reversed, the sound will be unnatural and will play without bass.

1 Fasten A to wall by 4 screws

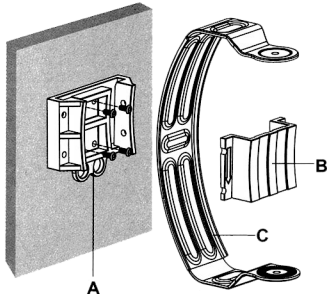

2 Attach C to A and lock B to A, and fasten screws

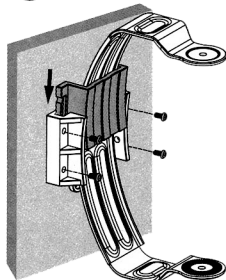

3 Wire the cable and cover the waterproof rubber

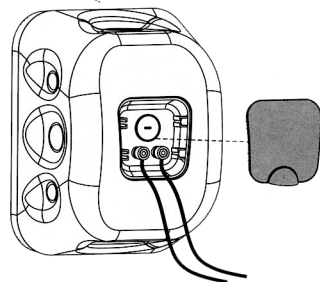

4 Screw the two knobs

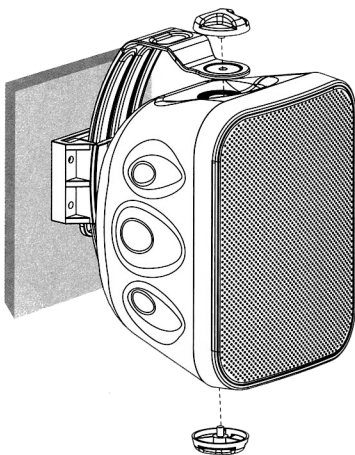

5 Fasten the screws after vertical and horizontal rotation

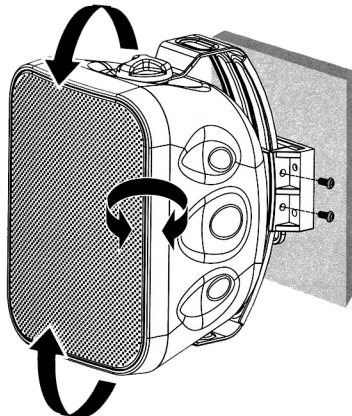

UNDERPOWERING VS. OVERPOWERING

- Most speaker damage is caused by amplifiers with too little power (wattage).
- An overdriven amplifier clips the waveforms and sends distortion to the speakers.
- Clipping is usually audible; it may vary from a harsh sound to a fuzzy or unclear sound.
- If you hear this condition at loud volume levels, turn down the volume until the distortion is no longer present.
- Damage caused by operating the speakers at distorted volume levels is not covered by the warranty.

EXAMPLE OF 70V/100V SYSTEM CONFIGURATION

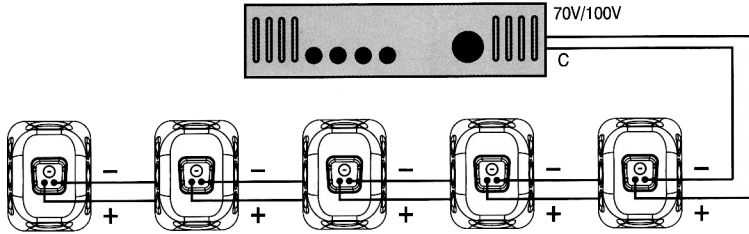

5 SPEAKERS CONNECTED IN PARALLEL USING 16W TAPS

NOTE: The total number of speakers multiplied by the tap value cannot exceed the output power (in watts) of the 70V /100V amplifier. The above example shows 5 total speakers. Using the 16W taps, you will need an amplifier with at least $(5) \times (16) = 80W$. A good rule of thumb is to select an amplifier with 20% greater power; in this case, an amplifier that delivers about 100W.

UNDERPOWERING VS. OVERPOWERING

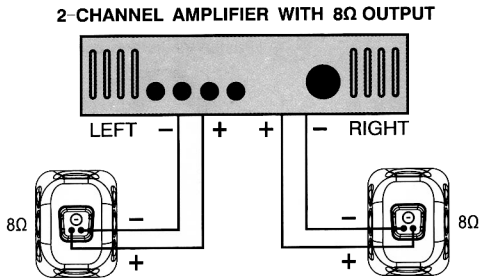

Observe correct Polarity for maximum Bass performance

2 SPEAKERS PER CHANNEL CONNECTED IN PARALLEL

TECHNICAL SPECIFICATIONS

Model	WS-7060BK
Frequency Resp(-10dB)(Hz)	60-20K
Sensitivity(1W/1M)(dB)	90
Impedance(ohm)	8
RMS power(watts)	60
Peak power(watts)	120
Transformer tapes	Without
Environment	IP56
Product Dimensions(mm)	190x256x225